

## **Prestigio P170T / P190T**

### **User's Manual**

## **U.S.FEDERAL COMMUNICATIONS COMMISSION RADIO FREQUENCY INTERFERENCE STATEMENT**

### **INFORMATION TO THE USER**

**NOTE : This equipment has been tested and found to comply with the limits for a**

Class B digital device pursuant to Part 15 of the FCC Rules. These limits are designed to provide reasonable protection against harmful interference in a residential installation. This equipment generates, uses, and can radiate radio frequency energy and, if not installed and used in accordance with the instructions, may cause harmful interference to radio communications. However, there is no guarantee that interference will not occur in a particular installation. If this equipment does cause harmful interference to radio or television reception, which can be determined by turning the equipment off and on, the user is encouraged to try to correct the interference by one or more of the following measures:

Reorient or relocate the receiving antenna.

Increase the separation between the equipment and receiver.

Connect the equipment into an outlet of a circuit different from that to which the receiver is connected.

Consult the dealer or an experienced radio/TV technician for assistance.

## 1. Introduction

This manual contains instructions for installing and operating Prestigio P170T / P190T. Prestigio P170T / P190T is a highly ergonomic color display unit.

- 17"/19" viewable SXGA LCD
- High quality screen re-scaling capability
- 100-240V AC input voltage, DC 12V 3.5A Adapter
- VESA DPMS (Display Power Management Signaling)
- VESA DDC1/2B compatibility
- Advanced digital On-Screen-Display controls
- Fast and accurate auto adjustment
- Most advanced image scaling
- Supporting VESA Flat Panel Monitor Physical Mounting Interface

## 2. Safety Information

This Monitor has been engineered and manufactured to assure your safety. You can prevent serious electrical shock and other hazards by keeping in mind the following:

Do not place anything wet on the monitor or the power cord. Never cover the ventilation openings with any material or touch them with metallic or inflammable materials.

Avoid operating the monitor in extreme heat, humidity or areas affected by dust. Temperature : 5~35°C. Humidity : 30~80RH

Be sure to turn the monitor off before plugging the power cord into the socket. Make sure that the power cord and the other cords are securely and rightly connected.

Overloaded AC outlets and extension cords are dangerous, as are frayed power cords and broken plugs, which may cause electric shock or fire. Call your service technician for replacement.

Do not use sharp tools such as a pin or a pencil near the monitor, as they may scratch the LCD surface.

Do not use any solvent, such as benzene, to clean the monitor, as it will damage the LCD surface.

### Cleaning and Maintenance

- To avoid risk from electric shock, do not disassemble the cabinet of the unit. The unit is not user-serviceable. Remember to unplug the unit from the power outlet before cleaning.
- Do not use alcohol (methyl, ethyl or isopropyl) or any strong dissolvent. Do not use thinner or benzene, abrasive cleaners or compressed air.
- Do not wipe the screen with sponge/cloth that could scratch the surface.
- To clean your antistatic screen, use water and special microfiber-screen-cleaning tissue-used in optical lens cleaning, or a lightly dampened piece of soft, clean cloth with water or mild detergent.
- If the instructions above do not help in removing stains, contact an authorized service agent.

### 3. Installing the monitor

#### 3-1. Packing List

The following items should be found in the package.

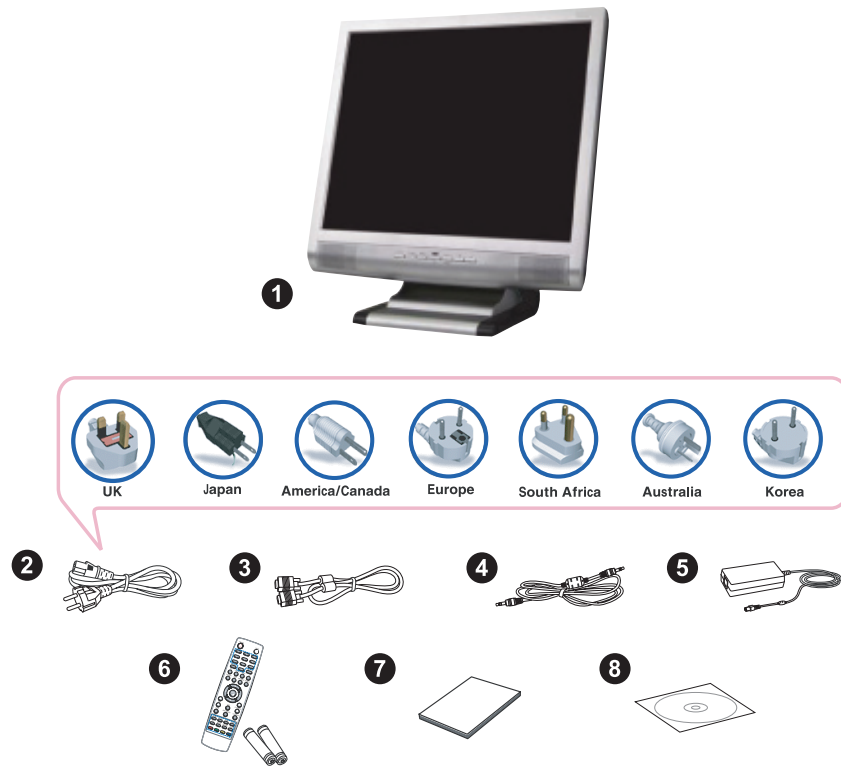

1. LCD monitor.
2. Power Cord
3. Signal Cable
4. Audio Cable
5. AC/DC Power adapter
6. Remote Control with Batteries (AAA x 2)
7. Installation Guide
8. Compact Disc

**Note:** The power cord above can be changed upon different voltage areas. Please contact your dealer if anything is missing or damaged.  
Other power cord's except the original packed in the product especially cards longer than 3m may affect EMC of the product in operating condition.

### 3-2. Selecting a suitable location

- Place the monitor at least 30cm from other electrical or heat-emitting equipment and allow at least 10cm on each side for ventilation.
- Place the monitor in a position where no light shines directly onto or is reflected on the screen.
- To reduce eye strain, avoid installing the display unit against a bright background such as a window.
- Position the monitor so that the top of the screen is no higher than the eye level.
- Position the monitor directly in front of you at a comfortable reading distance (around 45 to 90cm)

### 3-3. Connecting the monitor

Before you start cabling your monitor, check that the power is off on all units. To avoid any possibility of electric shock, always connect your equipment to properly earthed outlets.

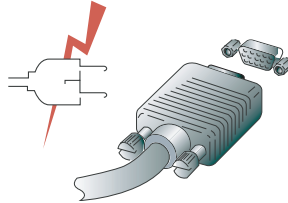

1. Insert the other 15-pin signal cable connector into the 15-pin VGA connection on your computer and screw it.
2. Plug the power cord connection to the connection on the monitor.
3. Plug the other end of the power cord to your computer's main supply or to a 100V-240V earthed electrical outlet.
4. Turn on the monitor using the power switch and check that the power LED is on. If not, repeat steps , 2, 3 and 4 or refer to the Troubleshooting section of this guide.
5. Turn on the power of the computer. The picture will appear within about 10 seconds. Adjust the picture to obtain optimum picture quality. See section Adjusting the picture in this guide for more information.

### 3-4. Connecting the TV

#### Connecting External A/V Devices

- Connect RCA (Yellow) or S-Video cables to an appropriate external A/V device such as VCR, DVD or Camcorder.
- Connect RCA audio cables to "Audio (R)" and "Audio (L)" terminals and the other ends to corresponding audio out terminals on the A/V device.

#### Connecting TV/CATV

- Connect an antenna or CATV cable to the antenna terminal on the back of the monitor.

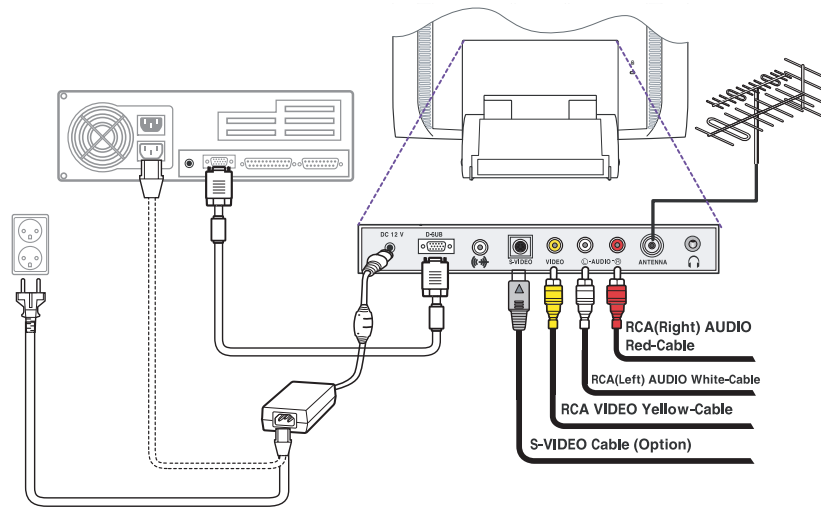

#### • Audio system

This monitor has an audio system including two micro loudspeakers. Each of two micro loudspeakers has an 2Wrms (typ.) output power. This system also supports a headphone output jack.



#### Note:

This system has been tuned to get a best tone quality which an audio input level is under 300mVrms. if the input level is more than 600mVp-p, you must tune down the audio input as the audio output tone may be distorted.

When the monitor is turned on, audio is always set up as off mode. Please use AUDIO direct access button on the front cover or On Screen Display to put audio on.

### 3-5. Setting the refresh rate

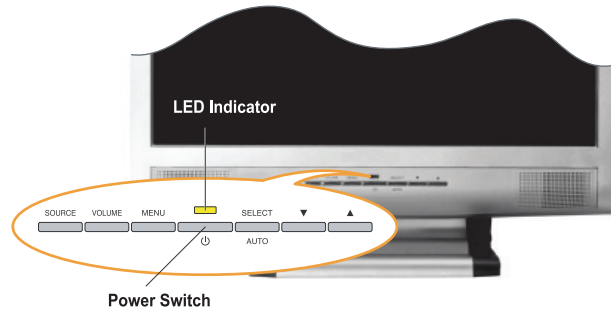

Follow the instructions below to set your refresh rate in Windows 98/ME/XP/2000.

1. Go to the configuration window (Start-Settings-Configuration window).
2. Double click on the 'Display' icon.
3. Click on the 'Settings' tab.
4. Click on the 'Advanced' button.
5. Click on 'Adapter' and select 60Hz from the list.
6. Click on 'Apply' to accept the selected value.

### Preset Timing Table

**Note:**

If the signal from the system doesn't equal to the preset timing mode, adjust the mode with reference to the user guide of videocard because the screen may not be displayed.

The recommended setting is a resolution of 1280x1024 and a refresh rate of 60Hz.

No.	Resolution	Horizontal Frequency	Refresh rate
1	720 x 400	31.5 KHz	70 Hz
2	640 x 480	31.5 KHz	60 Hz
3	640 x 480	37.5 KHz	75 Hz
4	800 x 600	35.2 KHz	56 Hz
5	800 x 600	37.9 KHz	60 Hz
6	800 x 600	48.1 KHz	72 Hz
7	800 x 600	46.9 KHz	75 Hz
8	832 x 624	49.7 KHz	75 Hz
9	1024 x 768	48.4 KHz	60 Hz
10	1024 x 768	56.5 KHz	70 Hz
11	1024 x 768	60.0 KHz	75 Hz
12	1152 x 864	67.5 KHz	75 Hz
13	1280 x 1024	63.9 KHz	60 Hz
14	1280 x 1024	80.0 KHz	75 Hz

### 3-6. User's Environment

#### Recommended Ergonomic User's Environment

- Viewing angle of the monitor should be between 0~20 degree.

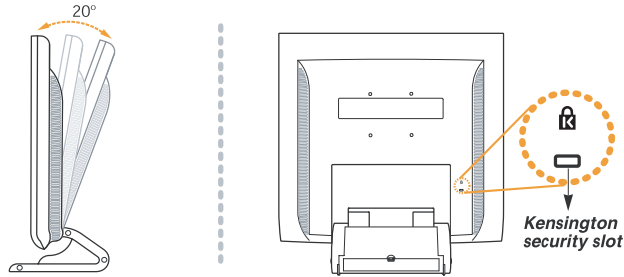

ENG

#### Kensington Security (Locking) Slot

- This display unit supports a Kensington-type security device to secure your monitor. Kensington lock is not included.
- To purchase and install the Kensington locking device, please refer to the following contact information.

##### \* Kensington Technology Group

• Address : 2000 Alameda de las Pulgas 2F san mateo, California 94403-1289  
• Tel : +1 650 572 2700 • Fax : +1 650 572 9675 • Web-site : [www.kensington.com](http://www.kensington.com)

#### VESA MOUNT'G

- This unit supports VESA FPMPMI standard for 75mmx75mm screw mounting by giving 4 screw holes inside the base stand of the unit.
- For buying VESA Flat Panel Monitor Mounting Devices, please contact the following .

##### Note:

Only M4 x10 size screw must be used for proper mounting. (Using wrong size screw may cause damages to the device)

##### \* Ergotron, Inc.

• Address : Ergotron Europe Kuiperbergweg 50 1101 AG Amsterdam The Netherlands  
• Tel : +3 1 20 696 60 65 • Fax : +3 1 20 609 04 59 • E-mail : [info.eu@ergotron.com](mailto:info.eu@ergotron.com)

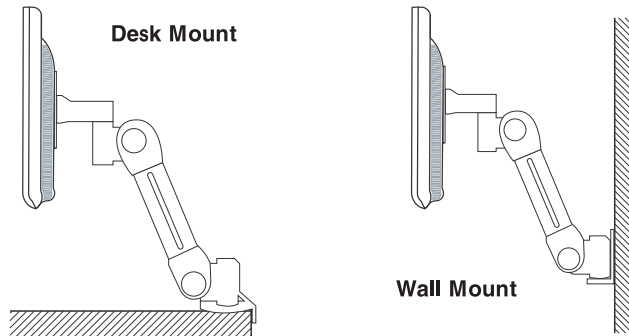



## 4. Adjusting the picture

### • Monitor

ENG

You can adjust the screen display by using the buttons located below the screen.

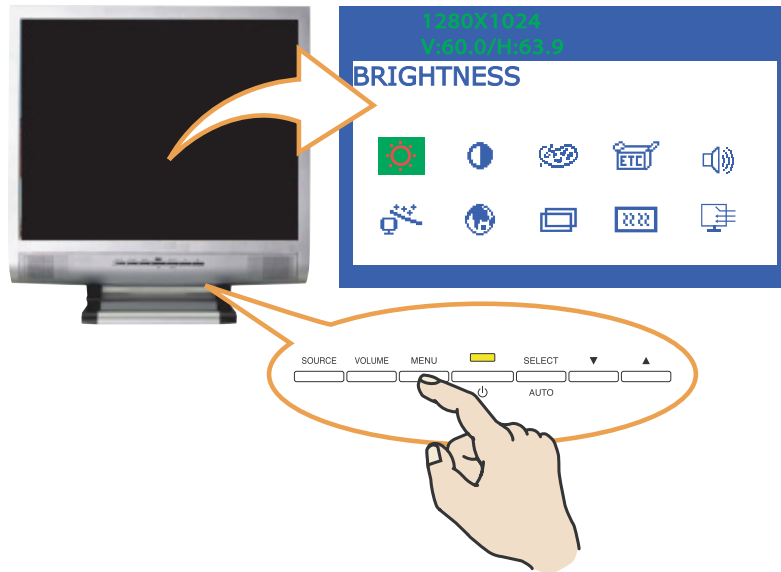

### 4-1. Using the On Screen Display

1. Push the MENU button to call the OSD to the screen. The resolution and frequency are displayed at the top of the menu box for your information.
2. Push the  $\vee$  or  $\wedge$  button to choose the item you want to adjust. The selected item is highlighted.
3. Push the SELECT button to adjust the highlighted item.
4. Use the  $\vee$  or  $\wedge$  button to adjust the selection.
5. Push the MENU button to return to the previous menu if you are in a submenu.
6. The display unit automatically saves the new settings in 1 second after your last adjustments and the menu disappears. You can also push the MENU button to make the menu disappear.

### 4-2. Direct access buttons

#### AUTO ADJUST

At first, a full screen such as Window's back ground will be displayed. Push the SELECT(AUTO) button to adjust the shape of the screen automatically.

#### VOLUME

Use the VOLUME button to select the volume adjustment. Adjust with  $\vee$  or  $\wedge$  button.





### 4-3. OSD Adjustments

The OSD adjustments available to you are listed below.

#### BRIGHTNESS

Adjusts the brightness of the screen.

#### CONTRAST

Adjusts the contrast of the screen.

#### COLOR CONTROL

Color temperature affects the tint of the image. With lower color temperatures the image turns reddish and with higher temperatures bluish.

There are three color settings available: BLUIISH, REDDISH or USER. With the USER setting you can set individual values for red, green and blue.

#### MISCELLANEOUS

##### RECALL

Recall the saved color data.

##### OSD TIMER

You can set the displayed time of OSD Menu window on the screen by using this adjustment.

##### OSD POSITION

Adjust the OSD menu's horizontal or vertical position on the screen.

##### AUTO COLOR

Optimum color setting is auto programmed for user's convenience.

#### AUDIO

##### VOLUME

Adjust the audio volume level.

##### SOUND OFF

This menu is used to choose audio on / off.

#### TREBLE

Emphasize high frequency audio.

#### BASE

Emphasize low frequency audio.

#### AUTO ADJUST

You can adjust the shape of the screen automatically at the full screen pattern.

#### LANGUAGE

You can select the language in which adjustment menus are displayed. The following languages are available : English, French, German, Italian, Spanish, Swedish, Finnish, Danish, Portuguese, Dutch, Russian, Japanese

#### H/V. POSITION

##### H POSITION

Adjust the horizontal position of the entire screen image.

##### V POSITION

Adjust the vertical position of the entire screen image.

#### CLOCK PHASE

##### PHASE

Adjust the noise of the screen image.

#### CLOCK

Adjust the horizontal size of the entire screen image.

#### SOURCE

No function. (Only supportable by the optional appliance.)

ENG



## 5. Adjusting the picture

• TV

ENG

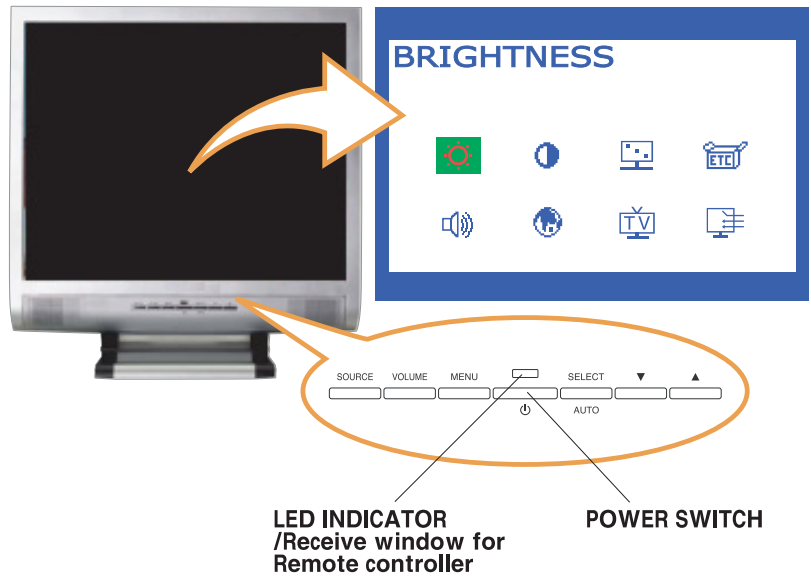

**LED INDICATOR  
/Receive window for  
Remote controller**

**POWER SWITCH**

### 5-1. Direct access buttons

#### SOURCE

Use this button to change the video source. Video sources are changed in the following order: PC > S-VIDEO > VIDEO > TV

#### VOLUME

Use this button to select the volume adjustment. Then, adjust with the Up or Down button.

#### MENU

Open the On-Screen-Display and select the highlighted function.

#### SELECT

Select a function on the OSD.

#### ∇/∧

Moves the selector right or left on the OSD. Increases or decreases the values of the selected function. Increases or decreases the channel number.



## 5-2. OSD Adjustments

The OSD adjustments are listed below.

### BRIGHTNESS

Adjust the brightness of the screen.

### CONTRAST

Adjust the contrast of the screen.

### IMAGE ADJUST

#### SATURATION

Adjust the color saturation of the video image.

#### TINT

Adjust the color Tint of the video image.

#### SHARPNESS

Adjust the sharpness and softness of the video image.

### MISCELLANEOUS

#### RECALL

Recall the saved color data.

#### OSD TIMER

You can set the time. The OSD Menu window will be displayed on the screen by using this adjustment.

#### OSD POSITION

Adjusts the OSD menu's horizontal or vertical position on the screen.

#### P190T ONLY TELETEXT(OPTION)

### AUDIO

#### VOLUME

Adjusts the audio volume level.

#### SOUND OFF

This menu is used to turn the choose audio on /off.

### TREBLE

Emphasizes high frequency audio.

### BASE

Emphasizes low frequency audio.

### LANGUAGE

You can select the language in which adjustment menus are displayed. The following languages are available : English, French, German, Italian, Spanish, Swedish, Finnish, Danish, Portuguese, Dutch, Russian, Japanese

### SOURCE

This menu is used to choose the desired input signal source.

There are four signal sources available :

Analog RGB : 15 pin D-sub, Analog signal

S-video : MINI DIN, Separate video signal

Composite Video : RCA Jack, Composite video signal

TV : Antenna or CATV signal

### TV

#### CH SEARCHING

This Function is to scan the broadcasting channels in your location.

#### PR(CH) EDIT

You can change the channel or PR No with this function.

#### CH FINE TUNE

To make the video image as clear as possible.

#### TV INPUT

Select a channel system : Air or Cable.

ENG

## 6. TV Functions

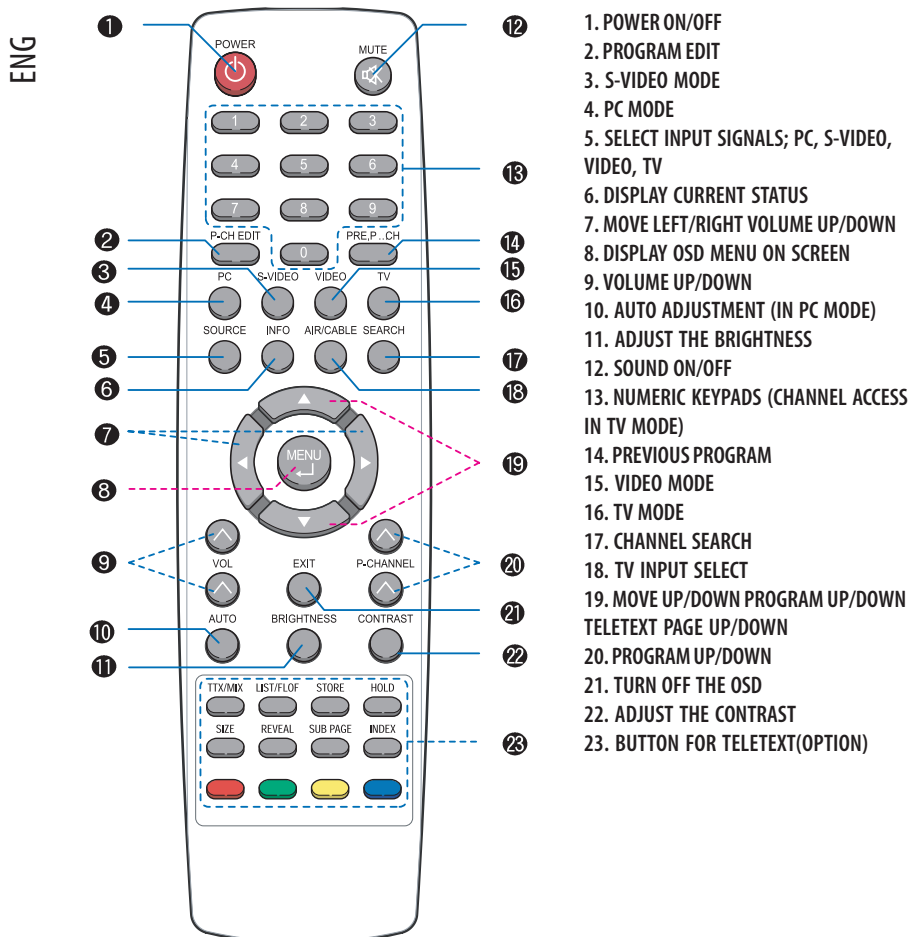

## PAL Channel Search

In order to watch TV, Multimedia Kit shall be installed to your monitor. Following instructions are based on using remote controller, and MENU button in remote controller is compatible with SELECT button of the monitor. You can scan for the frequency ranges available in your country.

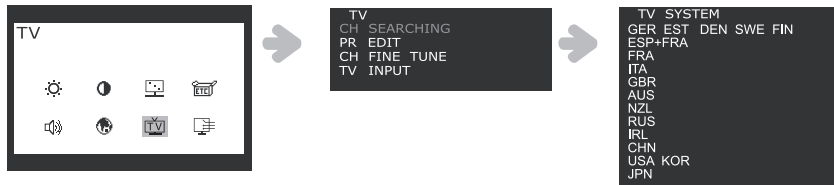

ENG

1. Press the MENU button and select TV icon.
2. Select CH SEARCHING and you can see country list.
3. Choose your country by +/- key, then press MENU button to go to PR SEARCHING. If your country is not listed, contact the distributors or service representatives.

### • Auto Pr

This function is to search the channels automatically.

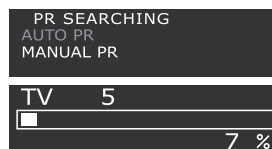

Select AUTO PR and press MENU button for automatic channel search.  
Scanned channels are automatically allocated to each PR No.

### • Manual Pr

This function is to store the channels manually.

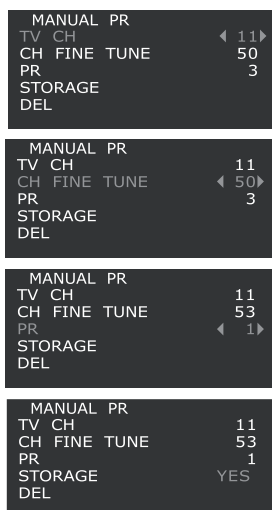

- a. Select MANUAL PR.
- b. Select TV CH by +/- buttons, then press MENU button. You can see <> at channel number.
- c. Change the channel by +/- buttons or numeric buttons, and press EXIT.
- d. If you choose CH FINE TUNE and press MENU, you can see <> at the number.
- e. You can tune the TV screen by +/- buttons, then press EXIT.
- f. If you select PR and press MENU, you can change the PR number by +/- buttons. Then press EXIT.
- g. You can save or delete above changes by selecting STORAGE or DEL button by pressing MENU button. When storage or delete is finished, you can see YES in the menu, then press EXIT.

ENG

## • PR EDIT (PROGRAMME EDIT)

The PR EDIT allows you to change the program numbers of stored channels.

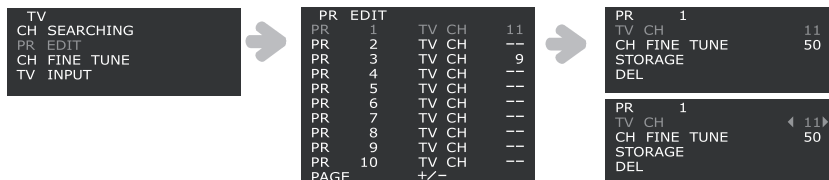

1. Press the MENU button and select TV ic
2. Select PR EDIT and press MENU button, then you can see the current PR list.

**Note:**

If you want to move to other pages, move the cursor PAGE +/- and press MENU button. Then you can move to the other page by pressing +/- button



3. Move the cursor to the PR number you want to change, then press MENU to go to the sub menu.
4. Select TV CH, then press MENU button. You can see <> at the channel numbers.
5. Change the channel by +/- buttons or numeric buttons, and press EXIT.
6. If you choose CH FINE TUNE and press MENU, you can see <> at the number.
7. You can tune the TV screen by +/- buttons, then press EXIT.
8. You can save or delete these changes by selecting STORAGE or DEL button by pressing MENU button. When storage or delete is finished, you can see YES in the menu, press EXIT to go back to the previous menu.

## P190T Only TELETEXT (Optional)

You can display teletext information from TV channels.

**– Displaying teletext information**

1. Press TTX/MIX button to display teletext mode.
2. To see the actual broadcast simultaneously with the teletext page, press TTX/MIX button again.
3. Press TTX/MIX button again to exit from the teletext mode.

**Note:**

If you press MENU when you watch teletext information, you can go back to the top page.

## • Other Functions

### 1. HOLD :

If the selected page is linked with several secondary pages, the secondary pages are displayed in sequence. To freeze the display on a given page, press HOLD button. When this button is pressed, the stop symbol is displayed at the top left corner of the screen and the automatic page change will be inhibited. If you press HOLD button again, the automatic change resumes.

### 2. REVEAL :

To see the hidden text (answers like quiz games), press REVEAL button.

### 3. LIST/FLOF :

To select between LIST mode and FLOF mode.

### 4. FLOF mode :

In FLOF mode, press the colored button corresponding to the topic that you wish to select. (The available topics are listed on the status information line) the page displayed with additional color-coded information that can be selected in the same way.

a) RED button : If you want to go to the previous page, press RED button.

b) Green button : If you want to go to the next page, press GREEN button.

### 5. STORE :

In LIST mode, you can store teletext pages with following step.

a. Select LIST mode, and you can see four 3-digit numbers are displayed in different colors at the bottom of the screen.

b. Press the colored button corresponding to the page that should be replaced.

c. Enter the new page number using numeric buttons.

d. Repeat steps b. c. for each page to be stored, using a different colored button each time.

e. Press STORE button until the corresponding blocks blink.

### 6. SIZE :

Press SIZE button once, the letter size of upper half of the screen will be doubled. Press SIZE button twice, the letter size of lower half of the screen will be doubled. Press SIZE button three times, the letter size gets normal.

### 7. SUB PAGE :

If there are secondary pages in current teletext information, you can go to secondary pages by pressing SUB PAGE and enter its 4-digit number.

## NTSC

## Channel Search

### TV INPUT

First of all, you can select the Air or Cable before setup the Channel Searching.

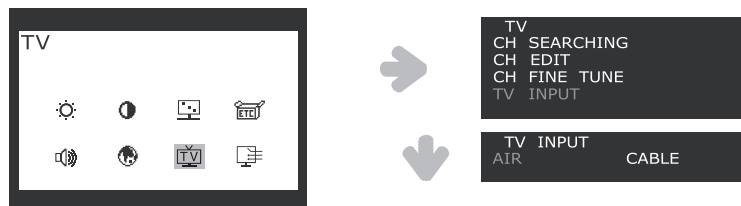

1. Press the MENU button and select TV icon.
2. Move cursor to TV INPUT using the +/- buttons.



3. Press the MENU to Select TV INPUT, then select AIR or CABLE by using the +/- buttons.
4. Press the EXIT button to go back to the previous menu.

You can scan for the frequency ranges available in your country.

ENG



1. Press the MENU button and select TV icon.
2. Select CH SEARCHING and you can see country list.
3. Choose your country by +/- key, then press MENU(.) button to go to CH SEARCHING. If your country is not listed, contact the distributors or service representatives.

### • Channel Edit



1. Select CH EDIT by +/- buttons, then press MENU button. You can save or delete above changes by selecting DEL or ADD button by pressing MENU button.
2. If you choose CH FINE TUNE and press MENU, you can see <> at the number.
3. You can tune the TV screen by +/- buttons, then press EXIT.

### • Channel Fine Tune



1. Select CH FINE TUNE by +/- buttons, then press MENU button. You can adjust CH FINE TUNE value by +/- buttons.
2. Press the EXIT button to go back to the previous menu.





## 7. Display power management

If the power management function of your computer is enabled, your monitor turns on/off automatically. You can control power management features from your computer.

### Reducing power consumption

Your computer may have power management features which enable the computer or monitor to enter a power saving mode when the system is idle. You can reactivate the system by pressing any key or moving the mouse.

Mode	LED	Power consumption
Normal	Green	40 W
off	Orange	P170T < 3.5 W / P190T < 5 W
Unplugged	Not illuminated	0 W

**Note:**

The power button does not disconnect the monitor from the mains. The only way to isolate the monitor completely from the mains supply is to unplug the mains cable.

## 8. Troubleshooting

### • TV

If this product is not functioning properly, you may be able to solve the problem by the following below ;

Problem	Possible solution
Color defects	If the screen color is not suitable for viewing. You can select "Recall" button in the OSD menu. This function returns to the initial factor setting values.
No channel searching	If it could not find channels please check it again according to the following steps. • The cable connection must be secure. • TV input (Air/CATV) • Country selection must be correct. You should select the appropriate country to your location.
Blue screen / No signal	If the screen shows only blue color or No signal message, please check whether you have selected the right signal source. Analog RGB, S-video, Composite-video, TV
The remote control does not work.	If the remote control does not operate well. Please check the batteries. • Batteries are correctly inserted according to (+) and (-) marking. • Batteries must be replaced if dead.

## 9. Troubleshooting

### • Monitor

If this product is not functioning properly, you may be able to solve the problem by the following below:

Problem	Possible solution
Blank screen	<p>If the power LED is not lit, push the Soft power switch or check the AC cord to turn the monitor on. If the unit is powered through the computer, check that the computer is switched on.</p> <p>The unit might be in standby mode. Push one of the keyboard keys. Check that the keyboard is properly connected to the computer.</p> <p>Check that the signal cable connector is properly connected and that the connection pins are not bent or damaged. If the connector is loose, tighten the connector's screws.</p> <p>Check that the power cable is correctly connected to the unit and to the power outlet.</p>
Error message: Video mode not supported	Check the resolution and the frequency on the video port of your computer. Compare these values with the data in the Preset Timing Table.
The display does not enter power management mode	The video signal from the computer does not comply with VESA DPMS standard. Either the computer or the graphics adapter is not using the VESA DPMS power management function.
Color defects	Check that the signal cable connector is properly connected and that the connection pins are not bent or damaged. Try another color temperature.
Size, position, shape or quality unsatisfactory	Adjust the picture characteristics as described in the section OSD Adjustment (4-3).
Duplicated images	A problem with your graphics adapter or display unit. Contact your service representative.
Image is not stable	<p>Check that the resolution and frequency from your PC or graphic adapter is an available mode for your monitor.</p> <p>In your PC, you can check through Control panel, Display, Settings.</p> <p>If the setting is not correct, use your computer utility program to change the display settings.</p>
Message : No signal	<p>Check that the signal cable connector is properly connected and that the connection pins are not bent or damaged.</p> <p>If the connector is loose, tighten the connector's screws.</p> <p>Check that the computer is switched on.</p>
The power LED is a orange color	<p>To enter a power saving mode. You can reactivate the system by pressing any key or moving the mouse.</p> <p>LED Indicator can be orange color on changing of video mode or Input Signal.</p> <p>Check the resolution and the frequency on the video part of your computer.</p> <p>Compare these values with the data in the Preset Timing Table.</p>

### Contacting service

If the above troubleshooting hints do not help you find a solution to the problem, contact an authorized service agent.

If the monitor is sent for service, use the original package if possible.

Unplug the unit from the power outlet and contact a service agent when:

- The monitor does not operate normally according to the operating instructions.

- The monitor exhibits a distinct change in performance.
- The monitor has been dropped or the cabinet has been damaged.
- The monitor has been exposed to rain, or water or liquid has been spilled onto the monitor.

## 9. Specifications

ENG

### Prestigio P170T

#### LCD

17"viewable, Diagonal, A-Si TFT

#### Pixel pitch

0.264 x 0.264mm

#### Display area

337.920 x 270.336 mm

#### Number of color

16.2Mil

#### Frequency rate

Horizontal : 31.0 to 80.0KHz, Vertical : 56 to 75Hz

#### Maximum bandwidth

135 MHz

#### Maximum resolution

1280 x 1024@75Hz

#### Recommended resolution

1280 x 1024@60Hz

#### Input voltage

DC 12V 3.5A

#### Power consumption

40W

#### Power management

VESA DPMS

#### Plug & Play

VESA DDC 1/2B

#### OSD menu

MONITOR : BRIGHTNESS, CONTRAST, COLOR CONTROL, MISCELLANEOUS, AUDIO, AUTO ADJUST, LANGUAGE, H/V. POSITION, CLOCK-PHASE, SOURCE

TV : BRIGHTNESS, CONTRAST, IMAGE ADJUST, MISCELLANEOUS, AUDIO, LANGUAGE, SOURCE, TV

#### Built in Speaker

2ch x 2watts

#### VESA FPMPI

75 x 75 mm screw mounting

#### Ergonomics, Safety and EMC

TCO, FCC Class B, CE, cTUVus, TUV-GS

#### Operating Temperature

5 ~ 35 °C

#### Weight

4.5Kg unpacked, 6.0Kg packed

#### Dimensions (W X H X D mm)

372 X 395 X 185 mm

- Specification is subject to change without notice for performance improvement.

PRESTIGIO P170T / P190T

19

ENG

## Prestigio P190T

### LCD

19"viewable, Diagonal, A-Si TFT

### Pixel pitch

0.294 x 0.294mm

### Display area

376.32 x 301.056 mm

### Number of color

16.7Mil

### Frequency rate

Horizontal : 31.0 to 80.0KHz, Vertical : 56 to 75Hz

### Maximum bandwidth

135 MHz

### Maximum resolution

1280 x 1024@75Hz

### Recommended resolution

1280 x 1024@60Hz

### Input voltage

DC 12V 3.5A

### Power consumption

40W

### Power management

VESA DPMS

### Plug & Play

VESA DDC 1/2B

### OSD menu

MONITOR : BRIGHTNESS, CONTRAST, COLOR CONTROL, MISCELLANEOUS, AUDIO, AUTO ADJUST, LANGUAGE, H/V POSITION, CLOCK-PHASE, SOURCE

TV : BRIGHTNESS, CONTRAST, IMAGE ADJUST, MISCELLANEOUS, AUDIO, LANGUAGE, SOURCE, TV

### Built in Speaker

2ch x 2watts

### VESA FPMPI

75 x 75 mm screw mounting

### Ergonomics, Safety and EMC

TCO, FCC Class B, CE, cTUVus, TUV-GS

### Operating Temperature

5 ~ 35 °C

### Weight

4.9Kg unpacked, 6.8Kg packed

### Dimensions (W X H X D mm)

420 X 441 X 185 mm

• Specification is subject to change without notice for performance improvement.